

MAPLE SYRUP

DIGEST



Vol. 23, No. 2

July 1983

BULK RATE
U. S. POSTAGE PAID
BAINBRIDGE, N. Y.
PERMIT NO. 12

Address Correction
Requested to:
Bainbridge, N. Y. 13733

G. H. GRIMM COMPANY, INC.

Maple Syrup Equipment — Hay Tedders

P. O. Box 130

Rutland, Vermont 05701

NEW



MAPLE SYRUP COLOR KIT — — — —

for grading consisting of a stainless steel holder 7" long with 5 slots, for 1 oz. sq. bottles; 3 slots have amber shaded glass pieces, imported from Germany and ground for us by a professional company who have matched the three pieces to co-inside with the Master sets at the U. S. Bureau of Standards for Maple Syrup in Washington, D. C., as evidence by light meter curves supplied to us, being correct to market.

The three colors are as follows:

1. U. S. Grade A "Light Amber" or Vermont Fancy or AA in Canada
2. U. S. Grade A "Medium Amber" or Grade A
3. U. S. Grade A "Dark Amber" or Grade B

Our kit has square 1 oz. bottles. Three containing glycerene must always stay in the kit in back of each glass. The other two to be used filled with a sample of syrup to be tested.

GEM EVAPORATOR — — 2 Ft. x 6 Ft.

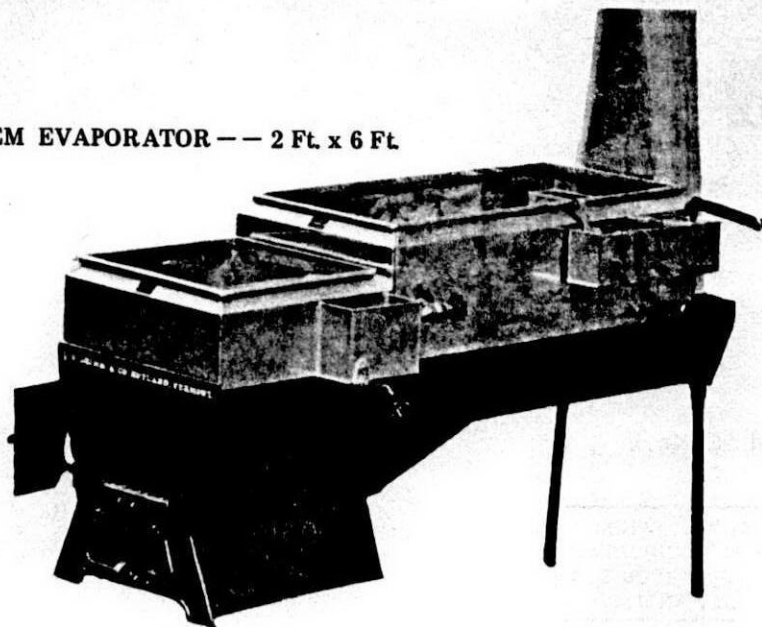

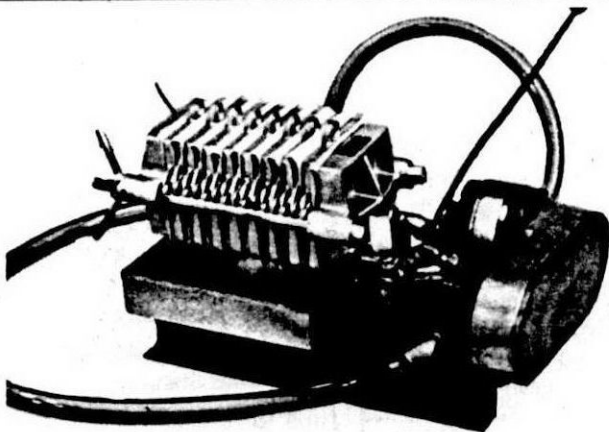

SYRUP FILTER PRESS

Uses 16 papers 7" square. Takes out all dirt and sugar sand. An electric motor operates a bronze gear pump to push the hot syrup through the filter and lift it to any height. Capacity 2 gallons per minute, 60 gallons per set of papers. 400 papers and 10 lbs. of Filter Aid included.

Everything for the Sugarmaker:

Spouts
Buckets
Covers
Tanks
Hydrometers
Thermometers
Pumps
Grates
Stack

Filters
Sugar Molds
Drills
Plastic Jugs
Plastic Tubing
Evaporators
(oil or wood)
Pails
Cans

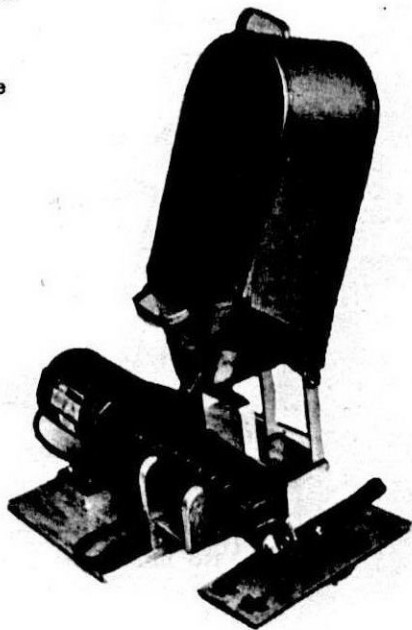

Cartons
Candy-making machines
Gas Evaporators
Steam Evaporators
Steam Hoods
Color Sets
Grade Stamps

SIPPLE SUGAR MAKER

A practical machine for making the finest grain of Maple Candy. It brings out the delicate maple flavor. A proven outfit with stainless steel Pig or Boiling Pan, stainless steel Worm and stainless steel Trough. With gear reduction motor. Makes 15 lbs. per batch.

THE MAPLE SYRUP DIGEST

Published & Edited by: Lloyd H. Sipple
R D #2, Box 126
Bainbridge, N. Y.
Phone: 607-967-7208

Published four times a year.
(Feb., July, Oct., Dec.)

Postage

Paid at Bainbridge, N. Y. 13733
Mailed outside our circulation
area for \$3.00 per year.

Printed by:

LaTourette Rapid Reproductions Inc.
13 No. Canal Street, Box 598
Oxford, New York 13830

NORTH AMERICAN MAPLE SYRUP COUNCIL DIRECTORY OF OFFICERS

Russell DavenportChairman
Shelburne Falls, MA 01370

413-625-2866

Gordon GowenVice-Chairman
Alstead, NH 03602

603-835-6531

Michael GirardSecretary-Treasurer
Simsbury, CT 06070

203-658-5083

DIRECTORS

Sandra Webber207-778-4234
Farmington, ME 04938

John Kroll612-732-2575
Long Prairie, MN 56347

Terry Healey616-582-7683
Charlevoix, MI 49720

J.L. Maxwell Spicer902-392-2823
Spencers Island, N.S. BOM 1SO

Arthur Merle, Jr.716-535-7136
Attica, NY 14011

Ture Johnson216-834-4206
Burton, OH 44021

Ronald Shaw705-325-6878
Hawkestone, ONT LOL 1TO

Edward Curtis717-253-3759
Honesdale, PA 18431

Wilson "Bill" Clark802-325-3203
Wells, VT 05774

Adin Reynolds715-449-2057
Aniwa, WI 54408

COVER PICTURE

Sugar house of Samuel E. Worthen, Bristol, NH. See article on page 9.

DIGEST ADVERTISING RATES

2 Page Spread . . . \$355.00

Full Page 190.00

1/2 Page Vert. or Hor. 105.00

Column Inch 15.00

Classified55 per word

Deadline for copy -

First of month preceding

Issue

FILTER BAG LINER

SAVES TIME

INCREASES LIFE OF BAGS



No need to remove filter bag from syrup filtering tank. Just remove liner from bag, rinse out solids in hot or cold water and replace. Liner has long life with careful use.

KOPEL FILTER PAPER COMPANY

2538 S. Damen Avenue, Chicago, Ill. 60608

Serving the Maple Syrup Industry
more than 25 years

Editorial

Although I haven't received a 1983 crop report, the grapevine tells me this year's production was below normal. Practically everywhere in New York the report is the same: about 60% to 70% of average. Pennsylvania, Ohio, Southern Michigan, Massachusetts and Connecticut, the warm states, made about the same or less. Vermont, New Hampshire, Maine, Wisconsin, Minnesota and Canada did better, about average. This was less than the bumper crop last year but enough to keep the bulk price down another year.

The retail prices I hear of are about the same as last year. Some places in Pennsylvania increased the price a dollar or two a gallon and I expect to see an increase later in the year when the supply begins to dry up. I didn't hear of as much price "cutting" this year and there wasn't the price "wars" going on that usually accompany a bumper crop. The law of supply and demand is working. It just needs a little more time.

In New York, where the crop was short, many producers were glad they carried over more good syrup from last year. Several years ago a producer told me he kept all his good syrup for his local sales, regardless of how much he had. The only syrup he sold commercially in drums was the dark or poor quality. Over a per-

iod of years he came about right. This system probably wouldn't work with a producer in a poor location or one who intends to bulk all of his crop, but most producers could benefit from the system and it would help the law of supply and demand work better.

This is just a case of everyone helping out when there's a problem to solve. I realize the colder producing areas are not helping get rid of the surplus these same areas produced the last two years. In fact, they're adding to it with another good crop this spring but that's not all their fault and we'll lick it yet. It's just going to take a little longer.



**Bascom's
Sugar House**
Alstead, N.H. 03602

Sugarin' Supplies

New & Used. Small Brothers'
Lightning Evaporators, buckets,
tanks, drums & supplies.

Osmonics R. O. Units.
U.S. Maple tubings & fittings
Bulk, wholesale, retail syrup
& custom packaging.



Ken
(603)
835-2230

Bruce
(603)
835-6361

NATURAL AND L. P. GAS BURNERS

Proven Since 1952

ELMER WINTER

11171 Sisson Highway, Route 75
North Collins, N. Y. 14111

FROM THE CHAIRMAN



Another year, another maple season, and another lesson from Mother Nature. The only reliable element in sugaring is the inconsistency of the conditions we deal with. Dramatic difference in volume and grade were apparent in many areas. I feel all in all there seems to be a near average crop.

I am happy to report that progress is being made concerning the adulterated syrup problem in Mississippi. A copy of the indictment is enclosed;

"On February 11, 1983, a grand jury sitting in the Southern District of Mississippi returned a thirteen-count felony indictment charging Oliver Anthony and Dewey Garland Clark with conspiracy to violate provisions of the Federal Food, Drug, and Cosmetic Act (one count) and with introducing or causing the introduction into interstate commerce, with the intent to defraud and mislead, of adulterated and misbranded foods (Oliver Anthony, twelve counts; Dewey Garland Clark, six counts). In particular, the indictment charges that substances, such as corn syrup, cane syrup, or invert sugar syrup, were added to defendants' honey, maple syrup, maple-flavored table syrup, and sorghum syrup products, resulting in the products being misbranded and adulterated. The case is assigned to District Judge Dan M. Russell, Jr., in the Jackson division. No trial has been set."

Our grateful thanks to Gordon

Gowan of New Hampshire, Vice-Chairman of the Council, who, while in Washington, D.C. talked with his congressman and got things moving. Ture Johnson of Ohio also helped. There is no doubt others have worked on this problem and I thank them, also. A full report will be forth coming after the trial. In the meantime let all of us give our support to the importance of this legal action.

Congratulations to Lin Lesure of Massachusetts and Gordon Brookman of New York who were inducted into the Maple Hall of Fame May 14th. They both richly deserve this honor.

Russ Davenport

SUGAR BUSH SUPPLIES CO.

- COMPLETE SUPPLIER TO THE MAPLE PRODUCER
- WE STOCK BACON JUGS, LAMB TUBING SYSTEM
- AUTUMN LEAF CANS, LABELS & CREAM TUBS
- LEADER, KING, VERMONT EVAPORATORS NEW & USED
- WE BUY USED EQUIPMENT & MAPLE SYRUP

Give Us A Call or
Write For Catalog

2611 Okemos Road
Mason, Michigan 48854
Tel - (517) 349 - 5185

Proposed Agenda

24th Annual Meeting

October 24 & 25, 1983

Grand Traverse Hilton Hotel
Traverse City, Michigan 49610

Sunday October 23 - Registration
at Hotel

Monday October 24 - Registration
desk open from 7:00 A.M.

8:00 a.m. - Business Session - Russ
Davenport

Roll Call - Secretary-Mike Girard

Reports - Secretary-Mike Girard

Treasurer - Mike Girard

Digest - Lloyd Sipple

Chairman - Russ Davenport

Delegate Reports - Province &
State delegates

Committee Reports & Announce-
ments

Leo Werner - IMSI Executive
Director

American Maple Museum

U.S. Pure Food & Drug

Appointed Committees

Any other - please contact Chair-
man

10:00 - 10:30 a.m. - BREAK

10:30 a.m. - This session will be in
charge of Ron Shaw and will cover
reports from Canada and concerns
from that part of the industry.

12:00 Noon - LUNCH

1:00 p.m. - Ron shaw - Canadian re-
port continued

1:45 p.m. - Terry Healey - Michigan
area presentations

2:30 p.m. - Michigan Tour - Terry
Healey

6:00 p.m. - Attitude Adjustment Hour

7:00 p.m. - Banquet
Master of Ceremonies

Speaker

Presentations

Tuesday October 25

8:00 a.m. - Continue Business Meet-
ing - Russ Davenport, elections,
etc. old, new, unfinished business

10:00 a.m. - BREAK

10:30 a.m. - Terry Healey -
Michigan reports

12:00 Noon - LUNCH

1:00 p.m. - Fred Laing - Research
and Development from all over
the maple country side

3:00 p.m. - Conclude

Note* An extensive trade show is
planned and interested dealers
should get in touch with Terry
Healey.

Also, there is a planned pro-
gram for the ladies, all ladies
are invited.

The above proposed agenda for
the October meeting of the North
American Maple Syrup Council was
submitted by Russ Davenport, Chair-
man. It is a draft for comment and he
invites other ideas and comments.
Send yours to: Russ Davenport,
R.D.#1, Shelburne Falls, Ma. 01370

EVERYTHING FOR THE MAPLE PRODUCER

Grimm, Lightning Evaporators,
Lamb Tubing and Supplies,
Bacon and Kress Jugs.

ORDER EARLY AND SAVE

HAROLD TYLER MAPLE FARMS
607-638-9474 Westford, N. Y. 13488

BUDDY SYRUP

Convert to marketable grades
by new FDA approved process
For information and prices contact
CLAUDE HILLS, Consultant

Flourtown, Pa. 19031
(215) 233-0132



Small Brothers inc.

Champlain Chevrolet Bldg.
Enosburg Falls, Vermont, USA
05450

423 Main Street
Dunham, Que. Canada
JOE 1MO

Tele. (514) 295-2451 2441

MANUFACTURERS OF A COMPLETE LINE OF SUGAR MAKERS SUPPLIES

FAMOUS SINCE 1890

OVER 50 U.S. DEALERS

EVAPORATORS

From 2 x 4 to 6 x 22
5 Models to Choose From

NEW and USED

Hobby model evaporator
Jil Fired Arches
Preheater hoods
Stainless steel pans
Gas finishing fires
24 x 30 to 4 x 6
Wood Finishing pans

Filter tanks
Sugar machines
Butter machines
Candy molds
Thermometers
Hydrometers
Storage tanks

Used buckets
Gathering buckets
Complete vacuum systems
SI-HI pumps
Filters
Heated canner
Pumps

Lightning

EVAPORATORS

"BUILT TO BOIL FASTER"



Reverse Osmosis 100-20,000 taps
16 models

Cut operating costs by approximately
75%. Designed for both small and
large maple operations.

New Economizer

Raithby Economizer

Utilizes all steam from existing
evaporator. Increase total
efficiency to 65%. Can be installed
on any evaporator. 40%
fuel consumption decrease.

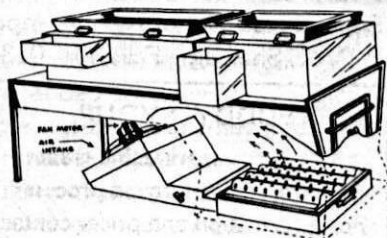
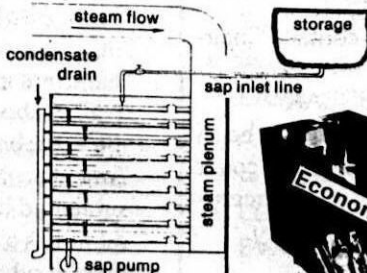

New Woodsaver

Increase your heat by 20% and burn 50% less wood! Im-
possible! Wrong, it is being done. Designed to be installed on
any make of woodfired arch.

Send me com-
plete FREE infor-
mation, catalog and
price list and nearest
distributor

Name _____

Address _____

Zip _____

Have your
representative
contact me as soon
as possible.

Telephone (____) _____

Number of Taps _____

Women's Page

Editor, Mary Lou Sipple

These recipes were included in a letter to us from Dr. C.O. Willits, "Will", to so many! (265 Medford Leas; Medford, N.J. 08055). Will and Mildred are "Fine". We try to keep in touch - maybe through the "Maple Syrup Digest"!!

MAPLE GLAZED CARROTS

- 1# carrots, cooked until tender
- 2 TB butter
- 1/4 cup maple syrup

Heat butter with maple syrup in a large skillet, saute drained carrots in maple-butter mixture until well glazed. Makes 4 - 6 servings.

CANDIED SWEET POTATOES

- 6 Medium sweet potatoes
- 3/4 cup maple syrup butter
- 1/2 cup water

Salt & pepper to taste

Cook potatoes until tender, then peel and slice lengthwise. Cover with syrup and dot with butter. Add water and seasonings. Bake about 35 minutes at 325 degrees. Makes 6 servings.

MAPLE APPLE

UPSIDE-DOWN CAKE

- 3 TB butter
- 1/2 cup maple syrup butter
- 2 medium red apples
- 10 maraschino cherry halves
- 1 1/2 cup sifted flour
- 2 tsp bkg. powder
- 1/2 tsp salt
- 1/4 tsp mace
- 4 TBS butter
- 3/4 cup sugar
- 2 eggs, separated
- 1/2 cup milk
- 1/2 cup grated apple

Melt butter in 9 inch square pan, add maple syrup and remove from heat. Cut cored, apples into half-inch slices and arrange in syrup with maraschino cherry halves.

Sift flour, baking powder, salt and mace together. Cream butter with one half cup sugar and unbeaten egg yolks until fluffy. Add sifted dry ingredients and milk alternately. Add grated apples.

Beat egg whites until stiff but not dry. Beat in remaining quarter cup of sugar and fold this into batter. Spread batter over the apples and syrup mixture and bake 350 Degrees for 40 - 50 minutes. Serve plain or with whipped cream.

New Hampshire

Our cover picture this issue was taken by the Rev. Robert Sanders. It is the sugarhouse owned and operated by Samuel W. Worthen, Bristol, NH.

Mr. Worthen told us, "This building is built on the foundation of a one room schoolhouse where my father and two uncles got their start. It was beyond repair when I started sapping in 1948, but we salvaged some timbers and wide boards and used them so the old schoolhouse, or parts of it, still can soak up some steam each spring."

Thank you, Sam, and may all your sap test four percent.

Maple Queen

1983 Northwest Maple Queen Chosen

by Joseph Beard

The second annual Northwestern Maple Queen Contest and banquet was held on May 23, 1983, at the Log Cabin Restaurant in Waterford, Pa. Following the Invocation, given by County Agent Joe Beard, a good meal was enjoyed by the forty-five producers in attendance. Charles Dengler, Saegertown, President of the N. W. Maple Producers' Association, introduced the guests and welcomed everyone to the event. John Deets, Titusville, Director of the Association, introduced the judges: Karen Kardosh, maple producer from Conneautville; Ray Kennerknecht, Crawford County Agent;

and Ron Kerr, Titusville, agricultural loan officer from Pennbank.

Kim Walberg, Wattsburg, the 1982 N. W. Maple Queen and the 1983 Pennsylvania Maple Sweetheart, reported on her local and state activities. In addition, she had the honor of crowning the 1983 N. W. Maple Queen Deanne Stahlman from Reno, Pa. Deanne is a seventeen year old senior from Rocky Grove High School where she was a member of the high school library staff, cross country team, band, choir and the Franklin Silver Cornet Band. Upon graduation from high school she will enter Clarion University to study business administration with a major in computer science. She received her maple experience from her uncle and aunt who run Deets Sugar House in the Titusville area.



**MAPLE
PRODUCTS, INC.**
JACKSONVILLE, VERMONT
05342

Tel: 802-368-2345

Dealer for a full line of maple sugaring equipment specializing in "Leader" and "King" evaporators.

Many sizes of gathering and storage tanks kept in stock as well as the small utensils used in making maple syrup.

Buying and selling of bulk maple syrup.

Processor and packer of maple syrup and candies in consumer packages.

Pennsylvania Tour

Bernard Tobin, Cambridge Springs, Vice-President of the N. W. Maple Producers' Association, discussed the State Maple tour which takes place September 23 and 24, 1983, in the Northwest area. The headquarters for the event will be the Corrian Hotel in Corry, Pa. The state banquet and the crowning of the 1983 Pennsylvania Maple Sweetheart will take place at the hotel. The group will visit maple sugar operations in the area, as well as other places of interest. Once every five years the Northwest has the responsibility of having the tour in our area. Tobin said more details of the event will be out shortly.

Lloyd Gates, Corry, and Charles Bush, Wattsburg, conducted the drawing and distribution of door prizes.

Association President Charles Dengler gave the closing remarks.

Vt. Maplerama

This year's Vermont Maplerama will be held on Friday and Saturday, August 5th & 6th at Bromley Mt. Ski area in Peru, Vermont, a few miles east of Manchester, Vermont on Route #11.

We start with an 8 am breakfast on August 5th at Bromley and all meals, tours, and exhibits will be centered at or out of Bromley.

For more information contact:
John Page, County Extension Agent
Box 559, Bennington, Vt. 05201

or

James White, County Forester
Box 980, Bennington, Vt. 05201

New York Tour

The Annual Maple Tour will be held August 1 and 2 (Monday and Tuesday) in Franklin and Essex Counties, which are located in the scenic High Peaks area of the Adirondacks of Northern New York.

The tour will be based at the Hotel Saranac of Paul Smith's College in Saranac Lake and busses will be used for transportation during the 2 day event.

Stops during the tour will include The Uihlein-Cornell Maple Research Facility at Lake Placid and three excellent maple operations located in the Keene and Keene Valley area. Also tour participants will have the opportunity to visit several Olympic Sites which played an important role in 1980 when Lake Placid hosted the Winter Olympic Games.

For more information on lodging, rates, etc., write to:

Ms. Kathy Berghorn
The Hotel Saranac, Paul Smith's
College
101 Main St.
Saranac Lake, NY 12983

AMERICAN MAPLE MUSEUM Cookbook

The American Maple Museum has completed its first cookbook. Single copies will be mailed for \$4.25 including postage.

Send request to:

American Maple Museum
P.O. Box 81
Croghan, N.Y. 13327

New York Maple Queen



Saturday, May 14th, was a very meaningful day at the American Maple Museum, Croghan, NY. It began with the usual pancake breakfast, but one of the highlights was six contestants competing for the title of New York State Maple Queen.

Reigning queen for 1983 is Jill Komrowski from Memphis, in Onondaga County. Alternate queen is Lori Jenne, Russell, St. Lawrence Co. The additional contestants were: Suzanne Hayner, Cherry Valley, Schoharie Co.; Amy Briot, Croghan, Lewis Co.; Jesse Meyer, Marathon, Cortland Co.; and Jennifer Chatterton, Mannsville, Jefferson Co.

The committee was very pleased with the interest and response of each contestant. Some of their reasons given for wishing to represent New York as reigning queen are:

1. Interest in meeting people and explaining the maple process and answering questions about maple.
2. Helping promote knowledge of and marketing of maple products.
3. An opportunity to make new friends.

The parade at 1:00 PM was followed by entertainment and a luscious chicken barbecue. Mother Nature cooperated by providing a sunny day with a 75° temperature.

Hall of Fame

Linwood Lesure was inducted into the American Maple Museum's Hall of Fame in Groghan, N.Y. on May 14, 1983 with his wife, Vera, at his side. Lin says he has gone as far as he can go in the Maple business.

An energetic and knowledgeable man, he was an organizer of the Berkshire Pioneer Producers' Association in 1947 that was re-organized as Massachusetts Maple Producers' Association, Inc. in 1976. He held the positions of Coordinator-Treasurer and President for many years. He was a charter member of the National Maple Council that grew into the North American Maple Syrup Council which he served as Chairman 1964-65.

Lin was born in 1904 on the family farm in Ashfield, Mass. He, Vera and son, Bob, came back to it after many years of traveling about the country on construction jobs to continue the dairy farm and maple business.

He was one of the first maple producers to install tubing and use pumps in 1958. He had to give up the dairy in 1952 after a heart attack so he put all his energy into sugaring and tree farming. He and Vera had the Maple Booth in the Massachusetts building at the Eastern States Exposition in Springfield, Mass. for many years.

An innovative Christmas Tree grower and Tree Farmer he harvested nearly all the lumber that went into their new home built in 1976 from his own farm after the old farm house and maple business had been sold. The house is situated so they can



Mr. & Mrs. Linwood Lesure and Mr. & Mrs. Gordon Brookman at the American Maple Museum.

look down the valley over many of the acres that were in the family for over 150 years. At the Eastern States Exposition on September 22, 1977 he was given the 2nd annual "National Outstanding Tree Farmer" award.

Gordon Brookman was inducted into the American Maple Museum Hall of Fame on May 14, 1983.

Gordon has lived in Chautauqua County since he was born in 1915. He started in the maple business as most everyone else, helping his folks make a little syrup from backyard trees. When he started out on his own farm in 1938 he bought a small sugaring outfit, tapped a bush and has made syrup ever since.

His major contribution has been his interest in organizations and the maple industry in general, not only locally but statewide and national. He helped organize both the Farm Bureau and Cooperative Extension Service when they were separated in 1954. He has served as director and president of the Chautauqua Co.

Farm Bureau and is still an active member.

Gordon helped organize the Western New York Maple Producers Assoc. about 1950, has been a director on the state board since 1956 and president from 1979-1981. He was delegate to the North American Maple Syrup Council from 1964 to 1981 and Chairman in 1978 and 1979. He started the Farm Bureau Maple Marketing Coop. in 1962 and helped organize the International Maple Syrup Institute in 1975.

He managed the Erie Co. Fair booth for about 6 years and has done just about everything that could possibly be connected with the Maple Industry from attending tri-ennial conferences at Philadelphia to judging maple products at the Pennsylvania Farm Show and the Toronto Exposition.

Gordon and his wife, Midge, who accompanied him at the museum, are taking a break from their maple activities at the present time but will no doubt return if the situation beckons.

KRESS originator of the packaging alternative

*Custom decorative designs:
one of our specialties.*

PURE MAPLE SYRUP
is one of Nature's purest sweeteners produced in the Spring of the year by condensing, through a process of evaporation, the sap of the sugar maple.



HOW TO KEEP PURE MAPLE SYRUP

After opening the can, keep in the refrigerator if possible. If large cans are purchased at this is not feasible, it is sometimes advisable to heat the syrup to the boiling point and recan in smaller containers. Add just a little water to compensate for the water evaporation.

Should the syrup start to ferment or have mold appear on top of the can, do not be alarmed. Heat to the boiling point immediately and strain. In most cases this will remove the syrup to good flavor. The flavor of syrup that has been kept for a long time can often be restored by heating.



Bluff Gardens, Inc.
Michigan
**PURE
MAPLE SYRUP**
made at Bluff Gardens
Harbor Springs, Michigan 49741

8 fl. oz.

1/2 pint



Submit your own layout



or your sugar house



or your state symbol



or your logo.



In all cases, choice of sugaring scenes in one or two colors.

**For highly effective MAPLE SYRUP marketing ...
choose KRESS ... the best jug plus so much more.**

KRESS

CREATIONS, INC. 349 Christian St. • Oxford, CT 06483 • (203) 264-9898

James Wallace Marvin Maple Research Award

The "James Wallace Marvin Maple Research Award", donated by the Vermont Maple Industry Council and the Vermont Maple Sugar Makers Association, was presented by Bill Clark, president of the Vermont Maple Sugar Makers Association, at the University of Vermont College of Agriculture Honors Day to Diane Yachimiak. Diane is a senior Biochemistry major in the Department of Microbiology and Biochemistry, at the University of Vermont. Her undergraduate research project

for the 1982-1983 school year was entitled "Classification of microorganisms associated with sugar maple by G-C ratio within their DNA". It was conducted within the Maple Research Laboratory, Department of Botany, under the direction of Dr. Morselli and Lynn Whalen.

The Maple Research Award was designed to be given to an outstanding student, such as Diane. She also received college honors within her department.



BAIN-GIRARD & CO.



**MICHAEL GIRARD
GREG GIRARD**

NEW & USED MAPLE SUGARING EQUIPMENT

We Are Agents For:

- **SMALL BROS. EVAPORATORS**
- **LEADER EVAPORATOR CO.**
- **TEKNIK EVAPORATORS**
- **U.S. MAPLE TUBING & FITTINGS**
- **KRESS JUGS**

Please Write For A Used Equipment Price List

**11 VILLAGE ROAD • SIMSBURY, CONN. 06070
PHONE (203) 658-5083 or (203) 658-0270**

Tubing

The following article is an original patent issued to William C. Brower, Mayfield, N.Y. on June 13, 1916. I wouldn't recommend trying it, even if you are interested, since it would be a bit difficult to purchase the materials. It was loaned to us by Bob Lamb. Ed.

To all whom it may concern:

Be it known that I, William C. Brower, a citizen of the United States, residing at Mayfield, in the county of Fulton and State of New York, have invented certain new and useful Improvements in Sap-Collecting Systems; and I do declare the following to be a full, clear, and exact description of the invention, such as will enable others skilled in the art to which it appertains to make and use the same.

My invention relates to improvements in sap gathering devices and has for its main object, the provision of simple means for tapping trees and conveying the sap to distant points.

In carrying out the above object, a further object of the invention becomes to construct the system in a plurality of detachably connected sections, and to provide novel means for uniting such sections.

With the above and minor objects in view, I employ the novel features of construction and combination herein described and claimed and shown in the accompanying drawings wherein:

Figure 1 is a perspective view showing the application of a portion of the system to use; Fig. 2 is a detail

side view of a portion of the main conduit and an end view of one of the branch conduits, showing the manner of connecting the two; Fig. 3 is a vertical transverse section through the main conduit as seen on the line 3—3 of Fig. 2 and showing a side elevation of one of the branch conduits and its connection with the main conduit; Fig. 4 is a transverse section as seen on the line 4—4 of Fig. 2; Fig. 5 is a horizontal section taken on the line 5—5 thereof; Fig. 6 is a perspective view of the lower end of one of the branch conduits and the attaching means thereon; and Fig. 7 is a detail vertical section showing more particularly the construction of one of the spiles and the parts coacting therewith.

In these drawings, forming a part of the present application, the numeral 1 designates a main line conduit which is formed in a number of detachably connected sheet metal sections 2, certain of these sections being equipped with hooks 3 which rise therefrom and which are adapted to be engaged with a wire 4 which is stretched tightly through the grove of sugar maples, from which sap is to be drawn. At various points, four-way couplings 5 may be provided for the attachment of branch conduits 6 which extend laterally from the main conduit 1. If desired, T-couplings or elbows (not shown) may also be provided for tapping the main line at suitable points, whereby branch conduits 6 may be led from said main line to practically any part of the grove.

As most clearly seen in Figs. 2, 3 and 4, the various sections of the main line are constructed of single

1,186,741.

Patented June 13, 1916.
2 SHEETS—SHEET 1.

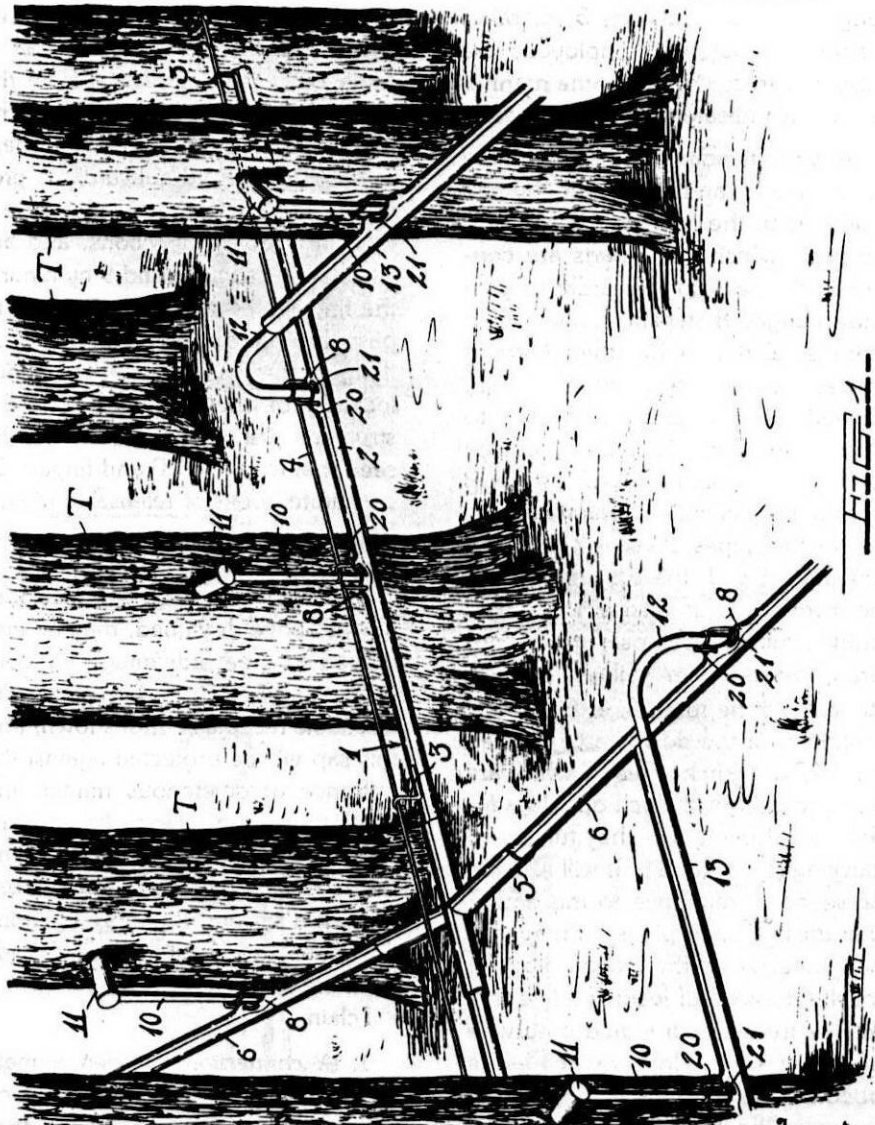

Inventor

W.C. Brower.

Witnesses

Edwin R. Hunt.
C. Munster

By *A. B. Wilson*

Attorney

longitudinal strips of metal which are bent to form a tubular structure, the edges of the strips being united by curling one edge 7 over the other edge 7'. The couplings 5, or other forms of couplings employed, are also constructed in the same manner as clearly indicated in the drawings.

At various points spaced along the main line 1 and along the branch conduits 6, the edges 7 of the metal strips of which these parts are constructed, are bent upwardly to provide flanges 8, which flanges lie in parallel relation to the other upstanding edges 7' of these strips, and are bowed laterally at their centers to coact with similarly laterally bowed portions 9 on said edges 7', to form substantially circular inlet openings in the various pipes. As seen more particularly in Fig. 1, these openings may be provided for receiving upright branch tubes 10 whose upper ends are provided with spiles 11 to be driven into the trees T, or for the attachment of the downwardly curved ends 12 of branch pipes 13 which are also provided with such openings for the attachment of the tubes 10 carrying the spiles 11. It will likewise be seen, by reference to this figure, that these branch pipes 13 may well be connected to the branch pipes 6, for the purpose of leading a line to a tree or trees which would otherwise be inaccessible. In most cases, it becomes expedient to provide whereby the branch pipes may be connected one with the other and whereby said branch pipes may be connected to the main line 1. For this purpose, any part of the device which is to be inserted between the flanges 8 and 9 at an opening, such

as a branch 13 is provided with an attachment which comprises a piece of wire having a coil formed therein intermediately of its ends and which encircles the member 13 and is then bent at right angles to form a pair of arms 20 which are spaced from the lower ends of the member 13. The lower ends of said arms are bent laterally and curved outwardly to provide retaining fingers 11 which extend in opposite directions, and are attached to flanges 8 and 9 by turning the fingers in the proper direction to pass them through openings in said flanges, thereby preventing the dislocation of these parts. From the structure just described, it will be seen that the arms 20 and fingers 21 constitute hooks or releasable means for securing the various parts of the device together.

The device constructed substantially as above described, may be employed to great advantage for conveying sap from the trees tapped, to a suitable receptacle (not shown) and this sap will be protected against the entrance of deleterious matter and likewise against injury by storms. Furthermore, the labor of collecting the sap is greatly reduced by the use of such a system, therefore lowering the cost of producing materials made from the syrup or sap.

I claim:

1. A connection between a main and a branch conduit, one of which has an opening in its upper face adapted to receive the other, upstanding flanges surrounding said opening and forming keepers, said flanges having apertures therein, the other conduit extending into said opening and provided with a pair of

1,186,741.

Patented June 13, 1916.
 2 SHEETS—SHEET 2.

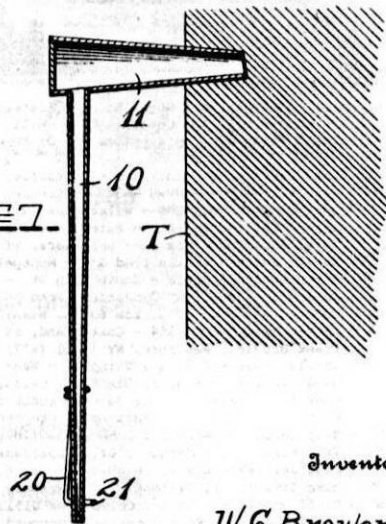
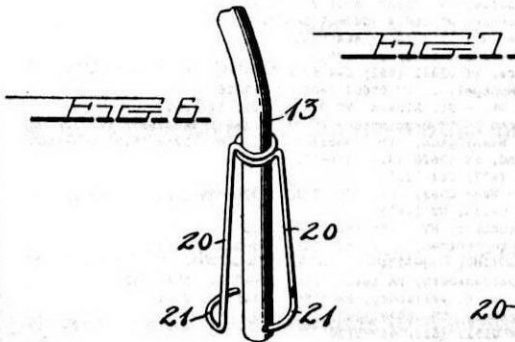
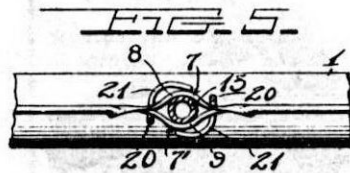
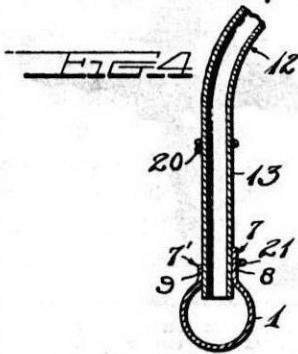
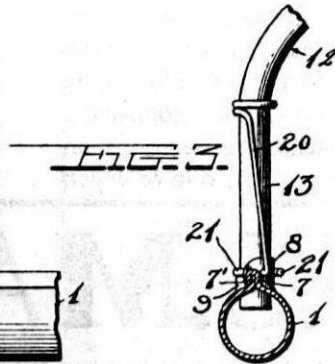
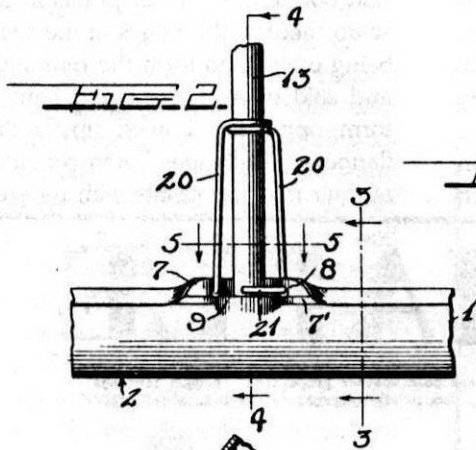

Inventor

W. C. Brower.

Witnesses

John R. Hunt.
 C. Munkin

By *H. B. Wilson*
 Attorney

arms spaced laterally from the lower end of the conduit and secured thereto at their upper ends, the lower ends of said arms being bent laterally and curved to provide retaining fingers adapted to pass through the openings in said flanges, whereby the branch and main conduits may be quickly and detachably connected.

2. A connection between a main and a branch conduit, one of which

is formed of a metal strip bent to form a tubular structure with the edges thereof united by curving one edge over the other, openings formed in said conduit at various points in the seam thereof, the edges of the seam being opened to form the openings, and said open edges being bent to form oppositely bowed upstanding flanges, said flanges being provided at their meeting points with register-

U.S. MAPLE

Green translucent maple tubing with excellent cold weather properties. Rugged fittings designed not to pull apart. Vacuum tight. Completely interchangeable with other brands.

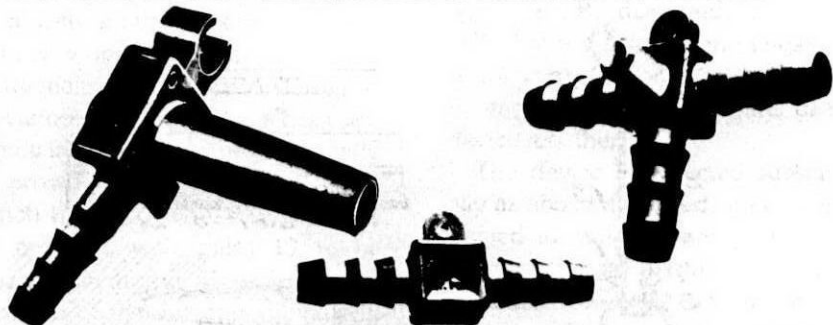

Bruce Bascom - Bascom's Sugar House - Alstead, NH 03602 (603) 835-6361, 835-2230 Owner
 Hilton Foote - R.D. #2, Cornwall Cider Mill Rd. - Middlebury, VT 05753 (802) 462-2472 Owner
 Aaron Hall - Maple Syrup Supplies - P.O. Box 245 - Pottersville, MI 48876 (517) 645-7305 Owner

VT - Nate Danforth - County Rd. - Montpelier, VT 05602 (802) 229-9536
 Sam Livingstone - NVRH - St. Johnsbury, VT 05819 (802) 748-5442
 Bill Coombs - Box 186 - Wilmington, VT 05363 (802) 464-5232
 Martin Collins - RFD 3 - Putney, VT 05346 (802) 387-5757
 David Buttolph - Box 66 - Belvedere, VT 05442 (802) 644-5756
 Donald Foote - Berlin Pond Ed. - Montpelier, VT 05602 (802) 223-7286
 Green Mountain Maple - South Main St. - St. Albans, VT 05478 (802) 524-2303
 Dale McLenithan - RD 2, Barbers Pond Rd. - Bennington, VT 05201 (802) 442-4521
 NY - Osborne Gaines - RD 2, Box 60 (N. Bennington, VT) - Hoodsick Falls, NY 05257 (518) 686-5505
 Warren Allen - Box 254 - Castorland, NY 13620 (315) 346-6706
 Frank Brodie - Westford, NY 13488 (607) 264-3225
 Charles Hoag - Military Turnpike - West Chazy, NY 12992 (518) 493-5444
 Dave Nascimbeni - RD 2, Box 816 - Cairo, NY 12413
 Charles L. Metzger - Box 34 - Warrenburg, NY 12885 (518) 623-2226
 Lansing Burdick - 335 East Rd. - Stephentown, NY 12168 (518) 733-5591
 ME - Bill Webber - Farmington, ME 04938 (207) 778-4234
 PA - Troy Firth - 136 Mechanic St. - Spartansburg, PA 16434 (814) 654-7338, 654-7265
 Dale Jeffrey - Box 15, Wagner's Rd. - N. Salisbury, PA 15565 (814) 662-2904
 CT - Mike Girard - 11 Village Rd. - Simsbury, CT 06070 (203) 658-5083
 NH - David Douglass - Center Conway, NH 03813 (603) 447-5120
 Richard Moore - RD 8 (Loudon) - Concord, NH 03301 (603) 267-8217
 MA - Devon Lane Farm Supply - Daniel Shays Hwy - Belchertown, MA (413) 323-6607
 MI - Dodd's Sugar Shack - 1654 Dodd Road - Niles, MI 49120 (616) 683-3283 Evenings
 Elm River Sugarbush - Ted & Janet Johnson - Rt. 1, Box 104 - Toivola, MI 49965 (906) 288-3434
 WI - Polak's Sugar Bush - Rte. 2 - Merrill, WI 54452 (715) 536-4032
 Roth Sugarbush - Rte. 1 - Cadott, WI 54727 (715) 289-3820, 289-3665

Agents wanted for certain locations. Contact any of the owners.

ing apertures, the branch conduits having their ends loosely mounted in said openings and provided with laterally extending curved fingers extending in opposite directions for engaging the apertures in the fingers.

3. The combination with a conduit having an opening surrounded with an upstanding flange provided with oppositely disposed apertures, and another conduit for insertion in said opening, a device for securing said conduits together comprising a strip of wire bent to form a coil which encircles the second conduit and which is extended to form parallel arms disposed on opposite sides of said conduit and having their lower ends bent laterally and curved outwardly to provide retaining fingers, the free end of one finger extending in one direction and the free end of the other in the opposite direction, said fingers extending through the apertures, in said flanges, whereby the conduits are detachably connected.

In testimony whereof I have hereunto set my hand in presence of two subscribing witnesses.



VACUUM TUBING INSTALLATIONS

- ★ We will survey your sugar bush and give you an estimate on cost.
- ★ IPL tubing stays in the woods all year.
- ★ We will travel anywhere in Western N.Y., Eastern Ohio or Northwestern Pa.
- ★ Expert team to assist in initial installation.
- ★ IPL vacuum tubing users had excellent productions in W.N.Y.
- ★ New & used evaporators. Big Savings.
- ★ Reverse Osmosis, woodsaver grates.

Call or Write Today!

SCHAMBACH'S MAPLE SYRUP

Equipment & Supplies
7288 Hayes Hollow Road
West Falls, N.Y. 14170
Phone: (716) 652-8189

American Maple Products

Newport, Vermont 05855

- produces maple syrup,
- buys bulk Maple Syrup from other producers,
- packs Pure Maple Syrup,
- makes Maple Candies, Maple Sugar and Maple Butter,
- wholesales these products to the retailer
- and supplies leading food manufacturers with Bulk Maple Syrup or Maple Sugar.

CAN WE HELP YOU WITH YOUR MAPLE REQUIREMENTS?

MAPLE & METAL

A WINNING COMBINATION
FOR OVER 100 YEARS



- ☛ Beautiful 4 Color Maple Scene for Greater Consumer Appeal.
- ☛ Much Longer Shelf Life.
- ☛ Will Not Become Brittle and Crack at Low Temperatures.
- ☛ No Oxygen or Moisture Vapor Transfer.
- ☛ Rectangular, For Better Use of Shelf Space.
- ☛ No Cancer Causing Compounds Used.
- ☛ Don't Settle for Less — Maple Deserves the Best.
- ☛ Warehouse Stock in Barre, Vermont — Cleveland, Ohio.

FOR CANS • CARTONS • SHIPPERS • LABELS

FOR THE DEALER
NEAREST YOU
CONTACT US

• • • • •
DEALER INQUIRIES
INVITED

MAPLE SUPPLIES COMPANY

WEST SECOND STREET (P.O. BOX 895)
BARRE, VERMONT 05641
IN VERMONT (802) 479-1827
IN OHIO (216) 247-2967



Milt Williams Lin Lesure Russ Davenport

Photograph Courtesy of Greenfield Recorder

Lin Lesure Award

Lin Lesure of Ashfield, Mass. has been a maple man from the very start. Operating a maple sugar house for a long time he was always a leader in using new techniques and procedures in making maple syrup. One of the first tubing set-ups and automatic operations in the processing of sap were used by Lin. He was a great promoter of maple both within the state of Massachusetts and the whole maple industry. He was one of the organizers of the Berkshire-Pioneer Maple Producers' Assoc. that later became Massachusetts Maple Producers' Assoc. and also one of the original directors of the National Maple Council which became the North American Maple Syrup Council. Lin was chairman of the Council 1964-65 and has been very active in maple ever since. At the annual meeting of the Mass. Maple Producers' Assoc. Lin received a plaque from

Russ Davenport, present chairman of the North American Council, in recognition of his work in support of the Council. As in most situations of this sort there is also some one else who must be recognized. In this case a great big "thank you" to Vera Lesure.

James Graves of Shelburne, Mass. was elected president of Mass. Maple Producers, taking over for Milton Williams of Deerfield who has held this position for ten years. Daniel Krug of Westhampton was elected Vice-President and Karen Cook of Worthington was elected Secretary.

Russ Davenport

WINDY RIDGE ENTERPRISES

36" Germicidal UV fluorescent bulbs - \$20 postpaid. Best prices in the US on HUSQVARNA 61, 266 and 181 chainsaws. Solid brass HUSQVARNA Belt buckles - \$6.50 postpaid. Buckle and belt - \$17.50 state pants size.

WINDY RIDGE ENTERPRISES
RFD #1, Ossipee, NH 03864



Morrow Retires

Professor Robert R. Morrow will retire at the end of this semester after

nearly thirty-four years of service at Cornell University. Bob started as an Assistant Professor of Forestry in 1949 following the completion of his Ph.D. at Syracuse University, College of Forestry. He was promoted to Associate Professor in 1954 and to Professor in 1970.

Dr. Morrow has established a noteworthy professional record in teaching and research during his years in the Department of Natural Resources. He is well-known and appreciated for his dedication to and administration of the Department's undergraduate teaching program. In addition to a long history of teaching woodland management and maple syrup production, Professor Morrow has been instrumental in the development of the undergraduate curric-

H. W. Cook Farm Service, Inc.

DeRuyter, N. Y. 13052

Serving the Maple Industry for
Over 60 years



Leader - King Evaporators
Gas & Electric Tree Tappers
Bits, Filters, Spouts
Sap Buckets, Covers
(new and used)
King Plastic Sap Bags
Metal Decorated Syrup Cans

Sugarhill Plastic Jugs
Rubber Candy Molds
Maple Cream Tubs
Lamb Tubing & Fittings
Pellets
Storage & Gathering Tanks

Open daily 8:00 - 5:00

Phone: 315-852-6161 and 315-662-7208

Write for Free Catalog

ulum, the organization and coordination of the advising program, and the advising of hundreds of students in the Department of Natural Resources and the College of Agriculture and Life Sciences.

Bob's research program is best known for his work on maple syrup production, including the use of tubing and pipe-lines for the collection of maple sap. He is regarded as an authority on sugarbush management. He planned, budgeted, and built the Arnot Forest sugar operation in 1956. With stimulus from grants from Mr. and Mrs. Henry Uihlein, he established the Uihlein-Cornell Experimental Sugar Bush (Heaven Hill) at Lake Placid, New York, in 1965 and has directed its operation and activities since. In 1966 he employed Lewis Staats as the Resident Man-

ager, and later obtained permanent funding for the position. Following the retirement of Fred Winch, Staats also assumed the State's maple extension program under the direction of Dr. John Kelley. With Bob's retirement, John will be responsible for continuation of the Uihlein-Cornell maple program.

Bob and Betty Morrow will be leaving Ithaca this summer to take up residence near Greenville, South Carolina. Their new property has a two acre rhododendron collection which Bob will try his hand at managing; not many "boardfeet" or gallons of maple syrup will be produced but unique beauty certainly will.

James P. Lassoie
Dept. of Natural Resources
Cornell University
Ithaca, New York

SPECIAL

CAR LOAD SALE

SPECIAL

SAVE ON YOUR

PLAIN 1 — GALLON MAPLE SYRUP CANS

Special price until supply gone

packed — 30 — 1 gallon cans per case

.60¢ each plus shipping charges

Order now and save

Write or phone



REYNOLDS

SUGAR BUSH INC.

ANIWA, WIS. 54408 Ph: 715-449-2057

WATERLOO "The Economizer"

**THE ENERGY AND LABOR SAVING
EVAPORATORS OF THE 80's**

**WATERLOO EVAPORATORS
HAVE BEEN PRODUCED
AND IMPROVED FOR OVER
60 YEARS.**

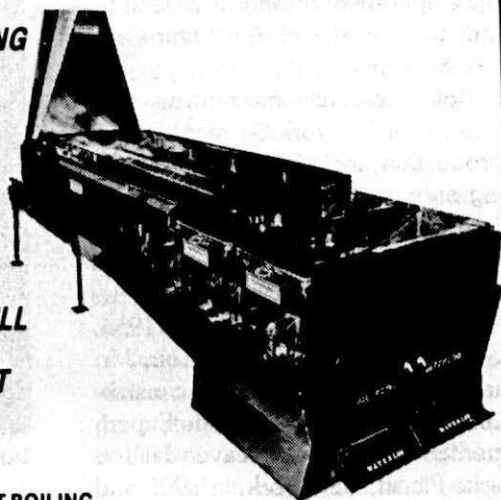

**A WATERLOO EVAPORATOR WILL
GIVE YOU A HIGHER OVER-ALL
RETURN ON YOUR INVESTMENT
THAN ANY OTHER MAKE.**

YOU GET:

**SPEED FOR TOP
QUALITY SYRUP**

**DURABILITY TO
STRETCH YOUR DOLLAR**

**ECONOMY
TO CUT OPERATING COSTS**

**SECURITY AND
EASE
OF OPERATION**

**LARGEST BOILING
SURFACE**

**REINFORCED SEAMS +
STRICTLY 22 GAUGE
STEEL USED**

**HIGHEST BTU CONVERSION
RATE IN THE INDUSTRY**

**TWO SAP LEVELS AND
DOUBLE FLOATS FOR
EXTRA SECURITY**

**REVERSIBLE RAISED BOTTOM.
FLUE PANS FOR COMPLETE
"ON ARCH DRAINAGE"**

**MULTIPLE FRONT PANS FOR
EASY AND SAFE HANDLING**

WATERLOO/ESCAN STEAM KETTLES

**A MUST FOR THE PRODUCER WITH
MAPLE SYRUP MARKETING IN MIND**

The WATERLOO/ESCAN steam kettles will reheat your syrup for sterile packaging, it will boil your syrup up to 255° Fahrenheit to produce your Maple Taffy, your Maple Cream, your Soft Sugar, your Candies and your Hard Sugar Blocks.

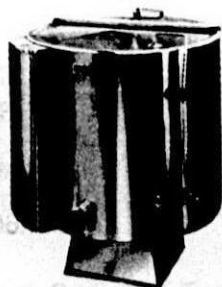

WATERLOO ALSO OFFERS THE FAMOUS ELECTROHOME R/O SYSTEMS

FOR OUR FREE 16 PAGES CATALOGUE AND NAME OF YOUR NEAREST DEALER

**WRITE TO: WATERLOO EVAPORATORS INC. 6064 FOSTER ST. WATERLOO,
QUEBEC, J0E 2N0 CANADA TEL.: (514) 539-3663**

B/P**BERLINER PLASTICS****THE INNOVATOR IN MAPLE SUPPLIES****B/P**

Berliner Plastics, Mike Berliner Pres., has a full line of MAPLE PRODUCTS including the ORIGINAL FORMULA GREEN WEATHER RESISTANT GRADE TUBING/ORANGE LO-HEAT MAINLINE. Our molds are producing super-tuff spouts/tees/6 ways etc. PLUS our line of MAPLE JUGS with/without GRADESTAY coating, and the ONLY LICENSED USDA PERMANENT GLASS GRADING KIT. See your B/P systems authorized distributor with his full line of maple equipment supplies. Distribution for ground floor opportunities. Contact us now:

SUGARHILL JUGS**TUBING SYSTEM DISTRIBUTORS****SYRUP RESALE****CONNECTICUT:**

Mike Girard, 11 Village Road, Simsbury, CT 06070..... 203-658-5083

MAINE:

Bill Webber, Farmington, ME 04938 207-778-4234

MASSACHUSETTS:

Al Hubbard, North St., Dalton, MA 413-442-2435

MICHIGAN:

Terry DeLoughary, Bark River, MI 49807..... 906-466-2305

Lucille Lesh, 2985 Everette, Harrisville, MI 48740.....

NEW HAMPSHIRE:

Marty Collins, Putney, VT 05346 802-387-5757

NEW YORK:

Erie County Brian Fahey, 6161 Genesee Rd, Lancaster, NY 14086 716-759-2962

St. Lawrence Jim Woodrow, Route 2, Hermon, NY 13652 315-347-2395

Otsego/Del. Matt Kent, R.D. #1, Franklin, NY 13775..... 607-829-8262

Cha. & Cat. Gary Peterson, RD 6, Box 192, Jamestown, NY 14701 716-665-3378

Lewis/Jeff. Warren Allen, RD, Castorland, NY 13620 315-346-6706

Gen. & Wyo. Dave Graziplene, North Java, NY 14113..... 716-457-9640

Sul. & Ora. Vern Meyer, Long Eddy, NY 12760..... 914-887-4108

Col. & Gre. Scotty Burdick, 335 East Rd. Stephenstown, NY 12168..... 518-733-5591

Clinton Barry Branon, 54 Cogan Ave., Plattsburgh, NY 12901 518-563-1063

ALL OTHER COUNTIES OPEN FOR NEW DISTRIBUTORS:**PENNSYLVANIA:**

John Deets, RD 5, Titusville, PA 16354 814-676-1097

J. Curtis Dom, Box 56, Wellersburg, PA 15564..... 814-324-4414

WISCONSIN:

John Roth, Roth's Sugar Bush, Route 1, Cadott, WI 54727..... 715-289-3665

VERMONT:

Ora. & Wash. Bill Gehr, RD 2, Barre VT 05641..... 802-479-2891

Caledonia Buckey Shelton, Sugarwoods Farm RFD 2, Glover, VT 05839..... 802-525-3718

Addison: Gil Goodyear, Bristol, VT..... 802-453-4825

Chittendon Chas. Elliot, S. Burlington..... 802-862-2497

Essex/Ori. Bill Moore, Box 43, Morgan, VT 05853..... 802-895-2764

Fra. & Lam. Dave Mayotte, RD 2, Fairfield, VT 05448..... 802-849-6810

Rutland R.C.M.P., Ed Merrow, RD, Danby, VT 05739..... 802-293-5378

Windham: VT. Disc. Supplies, Putney..... 802-463-9566

Windsor Chip Kendall, S. Woodstock, VT 05071..... 802-457-1473

Dave Harlow, RFD, Ludlow, VT 05149..... 802-228-7151

CANADA:

Don Atkinson, RR 1, Barrie, Ontario, L4M 4YB 705-728-5848

Ken McDonald, 38 Hillside Ave., Truro, N.S..... 902-895-1770

Jacques Morin, Valcourt, Quebec..... 514-761-6458

**USDA
Appr.****CANADA
Appr. &**

What every sugar maker has wanted.

USDA Approved Kit AVAILABLE NOW: \$65.00

Permanent (low cost) glass panel grading kits (certified to USDA/Canada Specs) obsoletes the nonapproved "Glycerine" type

**NEW: TRUCK CAPS (f-glas)
FORESTRY SUPPLIES
PLASTIC SHEET/BAGS**

See your B/P distributor, or contact:

Mike Berliner, Pres. / Berliner Plastics
1973 Lake Ave., Lake Luzerne, N.Y. 12846
518-696-2478



NEW ARRIVAL AT

sugarhill[•]

MAPLE CONTAINERS



- 100 ML
- Distinctive Shape & Colors
- Bennington Gray & Almond

Now in 6 Sizes

Quality Polyethylene Containers
with all materials F.D.A. approved

— SOLD BY DEALERS ONLY —

DEALERS AND ASSOCIATIONS CARRYING SUGARHILL JUGS

IN MAINE:

- ★ Kinney & Hodgkins Maple Supplies, Thorndike, ME 04986 (207) 568-3683
- ★ Kinney & Hodgkins Maple Supplies, Yarmouth, ME 04096..... (207) 846-4570

IN MICHIGAN:

- ★ Aaron Hall, 127 Church St., Box 245, Pottersville, MI 48876 (517) 645-7305
- ★ Dodd's Sugar Shack, 1654 Dodd Rd., Niles, MI 49120..... Evenings (616) 683-3283
- ★ Elm River Sugar Bush, Ted & Janet Nilson,
Route 1, Box 104, Toivola, MI 49965 (906) 288-3434

IN VERMONT:

- ★ Leader Evaporator Co., Inc., 25 Stowell St., St. Albans, VT 05478 (802) 524-4966
- ★ Coombs Maple Products, Inc., Jacksonville, VT 05342 (802) 368-2345

IN NEW HAMPSHIRE:

- ★ Dave Carta, P.O. Box 210, Rte 302, Glen, NH 03838..... (603) 383-9545
- ★ Harold H. Byam, Hunt Pond Rd., Hancock, NH 03449..... (603) 525-4445
- ★ Bascom's Sugar House, Crane Brook Rd., Alstead, NH 03602 (603) 835-2230
835-6361
- ★ Abbotts Farm, Rte 132, Box 156, Tilton, NH 03276 (603) 286-4095

IN WISCONSIN:

- ★ Reynolds Sugar Bush, Aniwa, WI 54408..... (715) 449-2057
- ★ Roth Sugarbush, Route 1, Cadott, WI 54727..... (715) 289-3820/289-3665

IN MASSACHUSETTS:

Massachusetts Maple Producers Association At:

- ★ Devon Lane Farm Supplies, Inc.
Daniel Shays Hwy, Belchertown, MA 01007 (413) 323-6607
- ★ James Ewen, 66 Elmwood Rd., Lunenburg, MA 01462..... (617) 582-6655
- ★ Richard Chandler, Murray Rd., Ashfield, MA 01330 (413) 628-3286
- ★ Jeff & Leann Mason, Kinnebrook Rd., Worthington, MA 01098..... (413) 238-7710

IN PENNSYLVANIA:

- ★ J. Curtis Dom, P.O. Box 56, Wellersburg, PA 15564 (814) 324-4414
- ★ Troy Firth, 136 Mechanic St., Spartansburg, PA 16434..... (814) 654-7338
- ★ Northwest Pennsylvania Maple Producers Association:
Bernard Tobin, RD 1, Cambridge Springs, PA 16403..... (814) 398-2085

IN VIRGINIA:

- ★ Highland Farmers Coop, Box 277, Flesher Ave, Monterey, VA 24465 (703) 468-2450

IN OHIO:

- ★ O.C. Stevens & Son, Maple Lane Farm, Mt. Gilead, OH 43338 (419) 946-3300
- ★ Richards Maple Products, 545 Water St. Chardon, OH 44024 (216) 286-4160
- ★ Fair Brothers, RFD 1, Ashland, OH 44805
- ★ Phillip Johnson, Mango Junction, OH.....

IN NEW YORK:

- ★ H. W. Cook Farm Service, Inc., DeRuyter, NY 13052..... (315) 852-6161/662-7208
- ★ Archie Miller, R.D.1, Hamden, NY 13782 (607) 746-2410
- ★ Ken Hufnagle, Crockett Hill Farm Inc., Box 15, R.D. 1
Martville, NY 13111..... (315) 564-6873
- ★ Justus "Dutch" Asthalter, Neversink, NY, P.O. Parksville, 12768 (914) 292-8569
- ★ Charles Emerson, R.D. 1, Alfred Station, NY 14803 (607) 276-6481
- ★ Claude Sisson Sr., Central Bridge, NY 12035 (518) 234-3194
- ★ Lansing Burdick, 335 East Rd., Stephentown, NY 12168..... (518) 733 5591
- ★ Charles Hoag, R.D. 1 Military Turnpike, West Chazy, NY 12992..... (518) 493-5444
- ★ James Woodrow, Rt 2, Box 59, Herman, NY 13652 (315) 347-2305
- ★ Warren Allen, Box 254, Castorland, NY 13620 (315) 346-6706
- ★ Michael Berliner, 1973 Lake Ave., Lake Luzerne, NY 12846..... (518) 696-2478

Letter To The Editor

Dear Mr. Sipple:

I'd like to tell you what happened to us making syrup this year. . . and this is the truth ' cause we wouldn't lie.

We had the best wood ever and boy did it make a hot fire . . .

Never boiled so fast takin syrup off all the time, it got so hot the flue stack caught the roof on fire. Had all we could do to make syrup. Weren't goina shut down - never made syrup this fast before. Started ripping shingle boards off the shack throwing'm in the evaporator to make syrup shoveling coals off the foor into the evaporator, finally ran out of sap when the shack was gone. . . all that was left was the evaporator standing and the wood stack outside. . . Boy did it get hot!

Mapleland Farm
Erhart, Ohio
Medina County
Kimble Bros.

EVAPORATORS & SUPPLIES

New & Used

LAMB TUBING & FITTINGS

ORDER EARLY & SAVE

ROGER C. SAGE

4449 SAGE ROAD
WARSAW, N. Y. 14569
Tel: 716-786-5684

Smada Farms Inc.

HAS:

Everything for the
MAPLE PRODUCER

New & Used Equipment

LAMB NATURALFLOW

KRESS JUGS

BACON JUGS

EVAPORATORS & PANS
Grimm - Lightning

LITHOGRAPHED
SYRUP CANS
Small Brothers

We Buy & Sell Bulk Syrup

Catalog available

Star Route Rt. 41 N
GREENE, N. Y. 13778

607-656-4058

CLASSIFIED

MAPLE INDUSTRY CONSULTANT — Layout and installation of vacuum tubing systems a specialty. Also, Feasibility studies and sugarhouse design. References. Available for work anywhere in the maple region. **DAVID R. MARVIN Johnson, VT.** 05656. 802-635-7483.

LES JONES' "Do It Yourself" Instructions available. For convenience buy your burner locally; use "Do It Yourself" **DETAILED** instructions for easy and **CORRECT** installation. **MRS. LES JONES, Holcombe, WI.** 54745.

WANTED: Agents or Distributors to sell complete line of Canadian Maple Syrup Equipment. **SMALL BROTHERS INC., P.O. Box 160, Dunham, Quebec, Canada.** **JOE IMO.** Tel: 514-295-2451.

FOR SALE: 14,000 gal. glass lined tank. Heavy plate, dished ends, will stand vacuum. **Sipple's Farm, Bainbridge, NY** 13733. 607-967-7208

6' X 9' CORRIGATED PAN/HOOD, use over fire in place of syrup pan. Ames 60 H.P. boiler. **Twitchell's Maple Farm** 802-824-5295

"CHIEFTAIN WILD RICE", the ideal companion item to sell with your delicious Maple Syrup. For full information write: **Chieftain Wild Rice Co. Rte. 9 Hayward, WI** 54843

WANT TO PURCHASE a small, used evaporator, either a 2' x 6' or 2½' x 8'. **Richard Nelson, Route 28, Box 215, Warrensburg, New York 12885.** Phone 518-623-9951.

3' x 10' Lightning s.s. pans; preheater hood; 4 x 16 Grimm wood fired complete, gas fired finishers, used tubing, Universal vacuum system, several Sapsucker vacuum pumps, used wood fired arches. **SMADA FARMS INC., Star Route, Greene, NY** 13778. 607-656-4058

FOR SALE

GRIMM EVAPORATOR 5 x 14 raised flue, stainless steel, 2 oil burners. Pre heater, excellent condition, a \$9800 value for \$5400.

REVERSE OSMOSIS MEMTEC model 100 \$6950.

SAP STORAGE TANKS Round bottom, with cap and heavy oak base: two 50bbl \$400 each; one 35 bbl \$290.

TRAILER 5 ton tag-a-long, tandem axel. New rubber, electric brakes, new springs, lights \$1350. **GATHERING TANKS** Two 500 gallon fiber glass tanks with saddle base for pick-up or trailer \$425 each.

USED TUBING 50¢ tap
½ inch x 3¼ inch tubing Make offer.
100' 2" tubing Make offer

SAP STOCK TANKS 8 410 gal.
\$75 4 320 gal. \$50 210 gal. \$35 180 gal. \$30 100 gal. \$20

HOMELITE PUMP \$195, suction hose \$20.

15 BBL GATHERING TANK Needs small fiber glass repair \$150.

30 SYRUP BARRELS \$7 each. **Dan Johnson Rt. 1, Box 265, Jaffrey, N.H.** 03452 603-532-7379

SHOW OFF YOUR FANCY SYRUP IN

JUGS BOTTLES JARS
**MAPLE PRODUCTS SELL
BEST IN GLASS**

**WE ALSO CARRY MANY
TYPES OF PLASTIC CONTAINERS**

INCLUDING THE KRESS JUGS.

Send for complete list.

M. R. CARY CORPORATION

**P. O. Box 122
Salina Station
Syracuse, N. Y. 13208**

BACON MAPLE SYRUP PACKAGING SELLS PURE MAPLE SYRUP



Dealers and Associations listed can supply you with:

- Bacon Jugs - 8 oz, pint, quart, 1/2 gallon and gallon.
- Our new 14 oz. Maple Leaf Flask & Labels.
- Custom printed jugs and custom printed labels.
- Individual Mailing Cartons and Multi-pack Shipping Cartons.
- Name and grade labels.

Everything we supply is backed by Charlie Bacon's promise of superior quality and service at a fair price.



BACON'S SUGAR HOUSE

JAFFREY CENTER, NEW HAMPSHIRE 03454

(603) 532-8836

DEALERS & ASSOCIATIONS CARRYING BACON'S JUGS

R.N. Johnson, Walpole, NH 03608	(603) 756-3321
N.H. Maple Producers Assn., Warehouse, Rt 106, Loudon, NH 03301	(603) 783-9961
Richard Moore, RFD No. 8, Concord, NY 03301	(603) 267-8217
Devon Lane Farm Supply Inc., Daniel Shays Hwy., Belchertown, MA 01007	(413) 323-6607
James Ewen & Sons, 66 Elmwood Rd., Lunenburg, MA 01462	(617) 582-6655
Donald Amero, W. Woodstock, VT 05091	(802) 457-3722
Dean Burrington, RD #1, E. Burke, Vt 05832	(802) 626-5730
Clark Brothers, Wells, VT 05774	(802) 325-3203
Coombs' Maple Products, Inc., Jacksonville, VT 05342	(802) 368-2345
The Dakin Farm, Ferrisburg, VT 05456	(802) 877-2936
Danforth's Sugar House, County Rd., Montpelier, VT 05602	(802) 229-9536
Hilton Foote, Cornwall Cider Mill Rd., Middlebury, VT 05753	(802) 462-2472
Leader Evaporator Co., St. Albans, VT 05478	(802) 524-4966
David R. Marvin, Johnson, VT 05656	(802) 635-7483
David Mayotte, Cary Rd., Fletcher, VT 05448	(802) 849-6810
Vermont Sugar House, Exit 3, 1-89, So. Royalton, VT 05068	(802) 763-8809
W. Barry Branon, 54 Cogan Ave., Plattsburgh, NY 12901	(518) 563-1063
Lansing Burdick, 335 East Rd., Stephentown, NY 12168	(518) 733-5591
Campbell's Maple, Smyrna, NY 13464	(607) 627-6653
Charles R. Emerson, RD 1, Alfred Station, NY 14803	(607) 276-6481
Farnum & Cumming Maple Products, Locust St., Roxbury, NY 12474	(607) 326-4226
	(607) 326-7569
David Nascimbeni, Glen Durham Sugarhouse, Cairo, NY 12413	(518) 622-9878
Larry Smith, Rt. 55, Box 177, Napanoch, NY 12458	(914) 647-5539
Harold Tyler, Maple Farms, Tyler Rd., Westford, NY 13488	(607) 638-9474
Ralph VanBrocklin, RFD No. 2, Canton, NY 13617	(315) 386-3036
Neil C. Wright, 28 Liberty St., Camden, NY 13316	(315) 245-1519
	(315) 245-1434
Northeastern Pennsylvania Maple Producers Association	(717) 689-2353
Court House, Honesdale, PA 18431	(717) 253-5970
Potter-Tioga Maple Prod., Assn., Coudersport, PA 16915	(814) 274-8540
Robert McConnell, Coudersport, PA 16915	(814) 274-9143
H.W. Russell & Sons Maple Farms, Rome, PA 18837	(717) 247-7361
Somerset County Maple Producers Association c/o Dale Jeffrey, Box 15, Wagners Rd., W. Salisbury PA 15565	(814) 662-2904
Sugar Bush Supplies, 2611 Okemos Rd., Mason, MI 48854	(517) 349-5185
Kinny & Hodgkins Maple Supplies, Thorndike, ME 04986	(207) 568-3683
Kinny & Hodgkins Maple Supplies, Yarmouth, ME 04096	(207) 846-4570
Maine Maple Products, Inc., Titcomb Hill, Farmington, ME 04938	(207) 778-3803
Wyman W. Manes & Son, East Orwell, OH 44034	(216) 583-2388
Richards Maple Products, 545 Water St., Chardon, OH 44024	(216) 286-4160
O. C. Stevens & Son, Maple Lane Farm, Mt. Gilead, OH 43338	(419) 946-3300
Reynold's Sugar Bush, Inc., Aniwa, WI 54408	(715) 449-2057
Ivan Puffenbarger, Rt. 637, Blue Grass, VA 24413	(703) 474-2771
Bacon Jugs Canada, Box 152, St. Andrews East, Que, JOV 1X0	(514) 562-2237

QUALITY AND SERVICE SINCE 1888

LONG LASTING

EVAPORATORS OF

ADVANCED

DESIGN

ENABLE A

RETURN ON INVESTMENT

KING EVAPORATORS



KING TANKS

SOULE SPOUTS

ALUMINUM STEAM HOODS

PARALLEL FLOW PREHEATERS

THANKS TO YOU THE MAPLE PRODUCER
LEADER EVAPORATOR CO. INC. IS NOW
ENTERING OUR 95th YEAR OF
CONTINUOUS SERVICE.

VERMONT EVAPORATORS

VERMONT SPOUTS

LAMB & MAPLEFLO
PIPELINE SYSTEMS

GAS and ELECTRIC
TREE TAPPERS

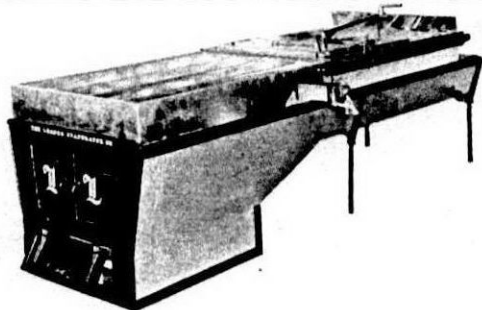

LEADER SPECIAL
EVAPORATORS

MONITOR TANKS

WARNER SPOUTS

CONTAINERS

O. O. CORRECT SIZE
MAPLE SYRUP CANS
5 SIZES

BACON -- KRESS -- SUGARHILL
PLASTIC JUGS

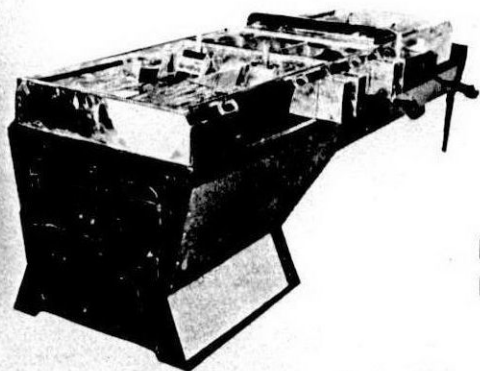

OWNED AND OPERATED BY PEOPLE INTERESTED IN
MAPLE TO BETTER SERVE THE MAPLE PRODUCER.

Leader Evaporator Co. Inc.

25 Stowell St., St. Albans, Vermont 05478

802-524-4966

802-524-3931

LAMB'S CORNER

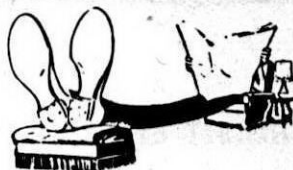

I'd like to say something about the
MAPLE SYRUP DIGEST.

It is the official publication of the
North American Maple Syrup
Council.

They try to send it to every maple
producer.

It is not subsidized by the Council.

It is self sufficient, operates en-
tirely on advertising and contribu-
tions.

Have you sent in you con-
tribution?

Does your association contribute?

We do - -

Robert M. Lamb
Box 368
Bernhards Bay, NY 13028

This is a paid advertisement